

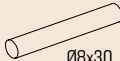





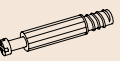

2/6 ANDREO NEW

			
B	D	E	F
5x	6x	3x	3x

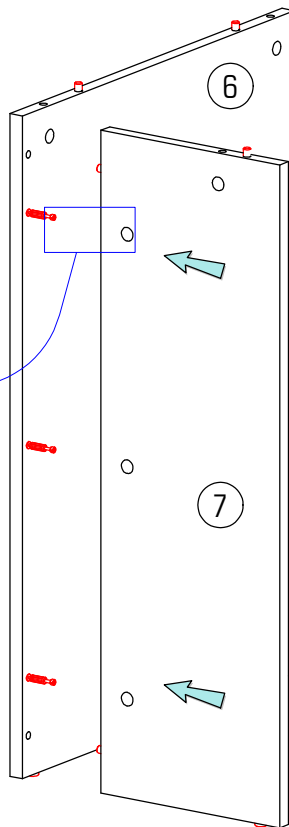
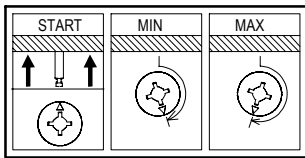
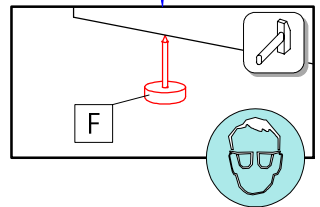
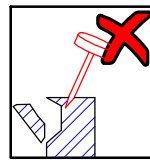
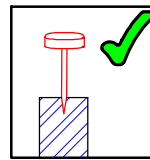
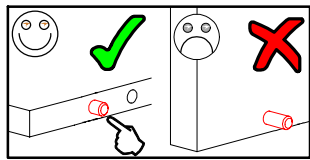
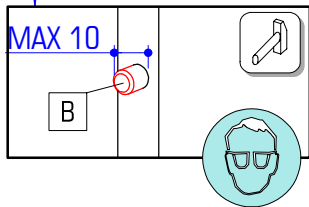
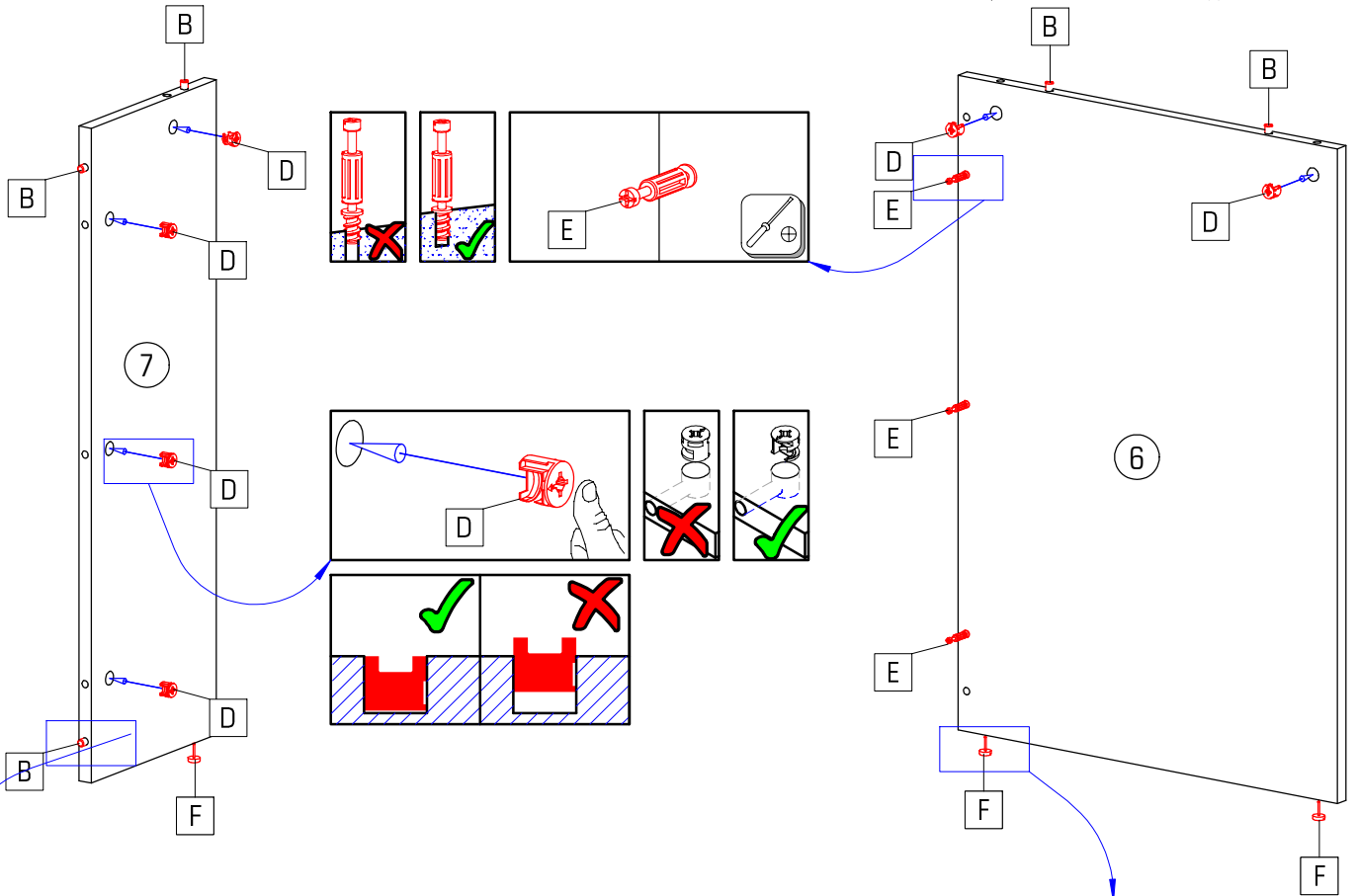
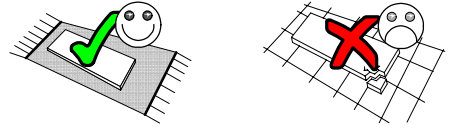
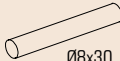

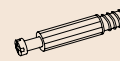

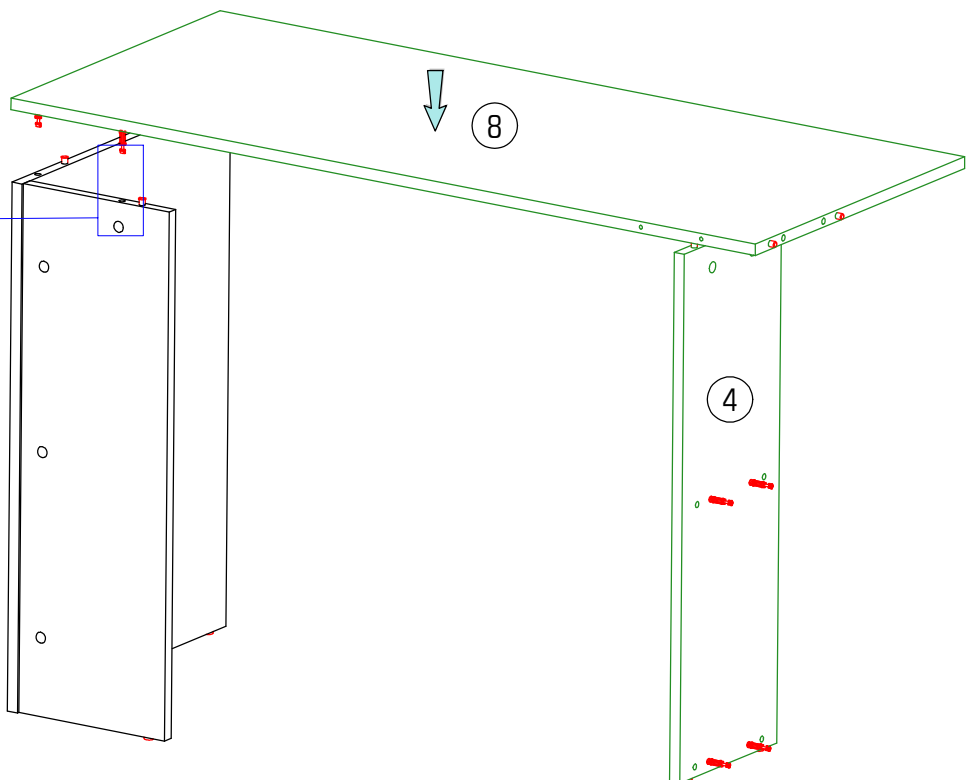
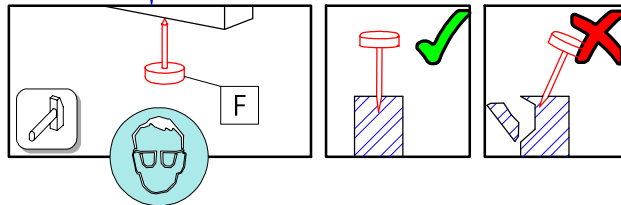
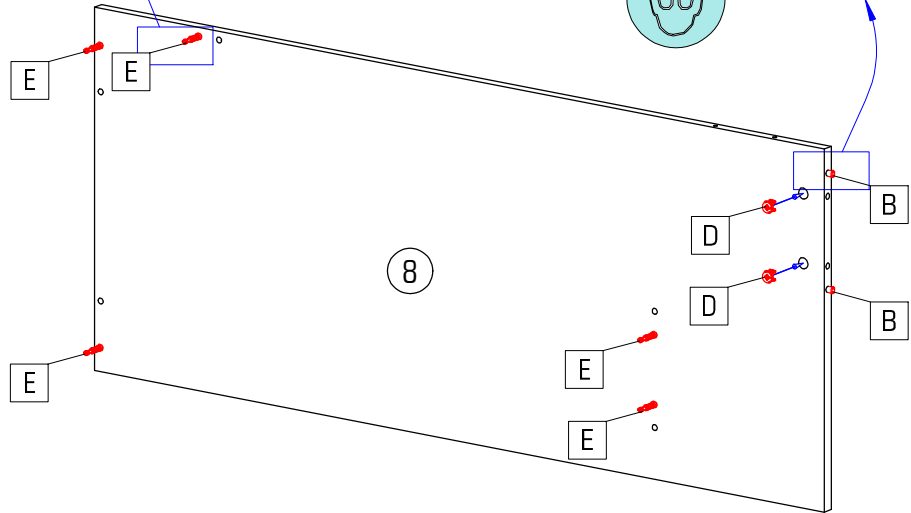
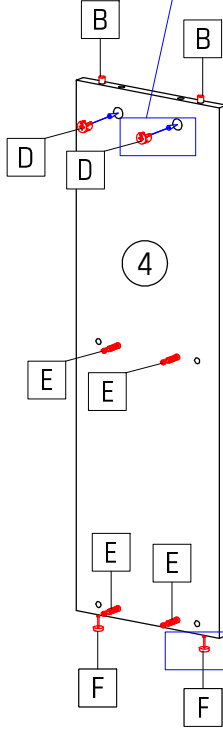
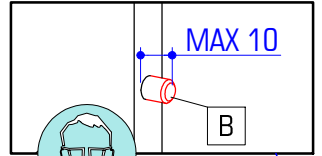
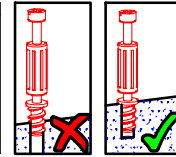
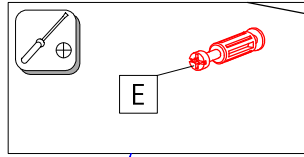
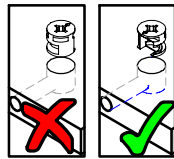
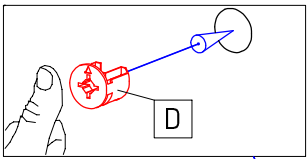
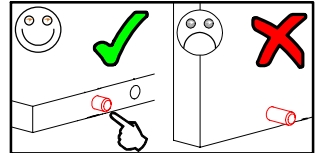
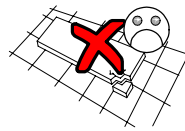
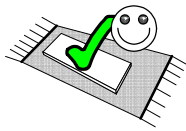

			
B 4x	D 4x	E 9x	F 2x

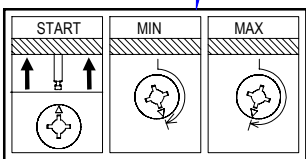

5x

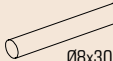

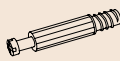

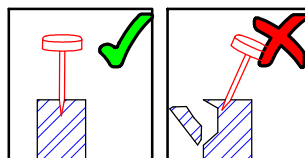
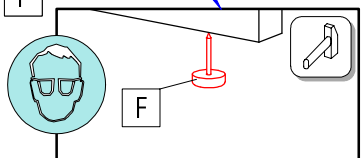
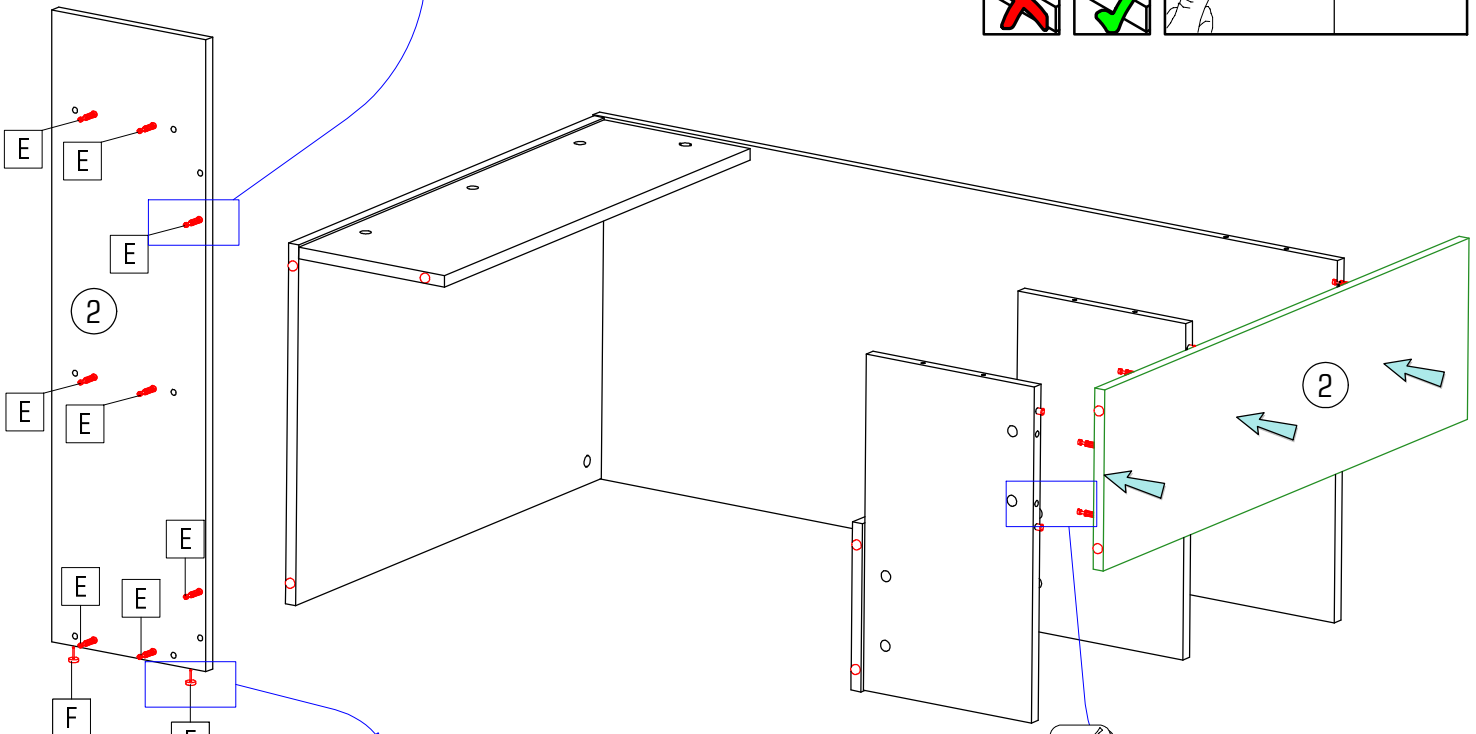
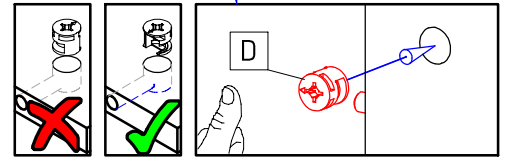
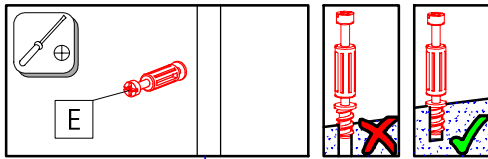
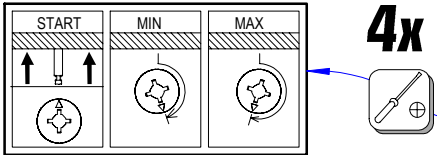
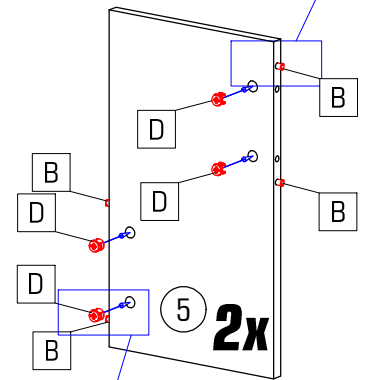
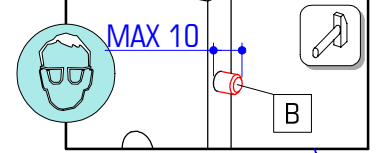
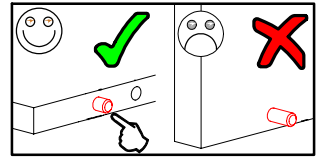
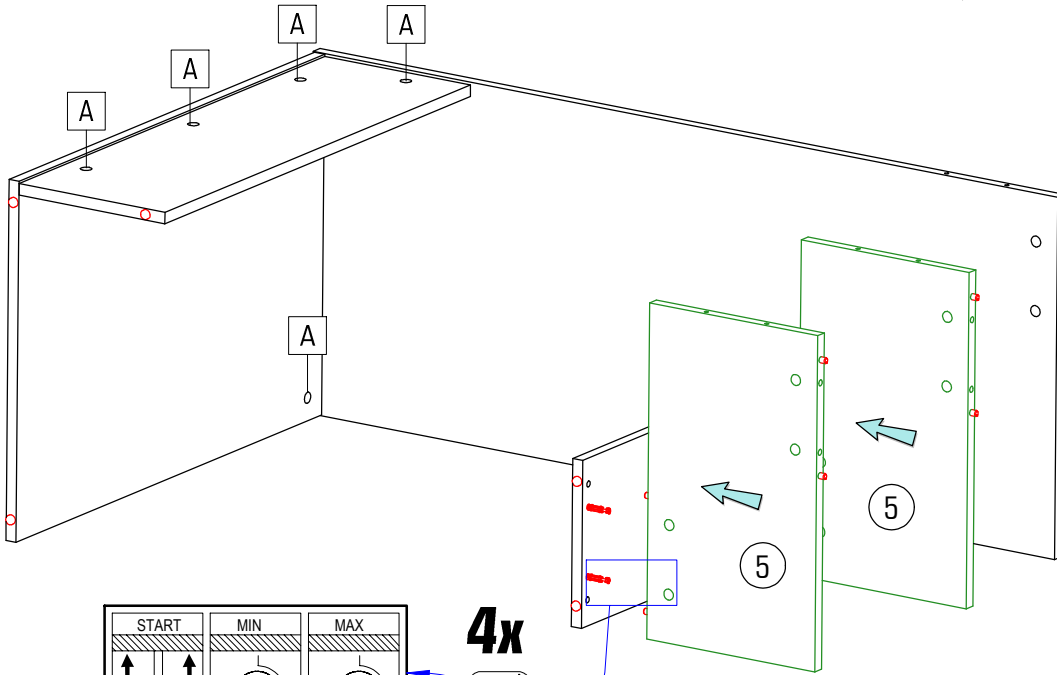
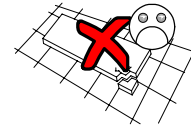
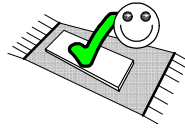

4/6 ANDREO NEW

				
A	B	D	E	F
8x	8x	8x	8x	2x

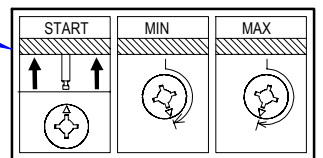

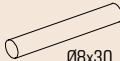

6x

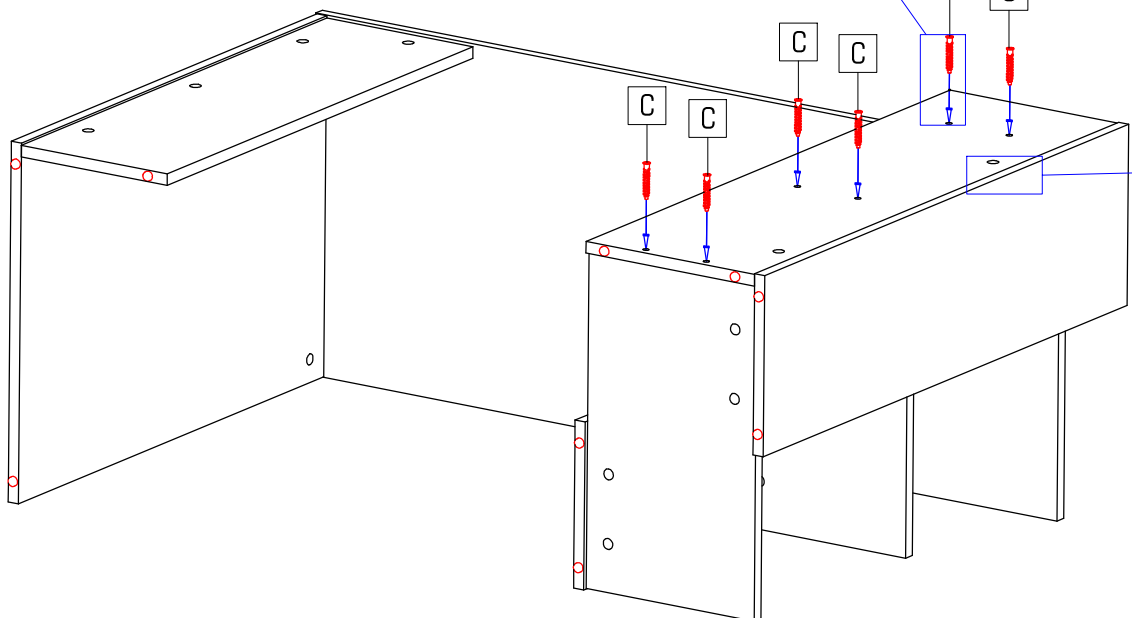
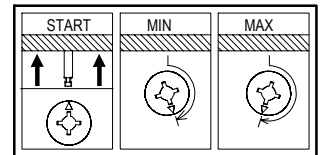
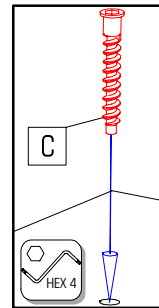
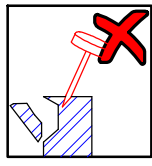
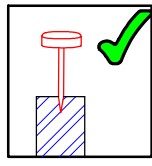
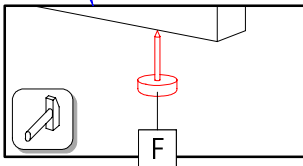
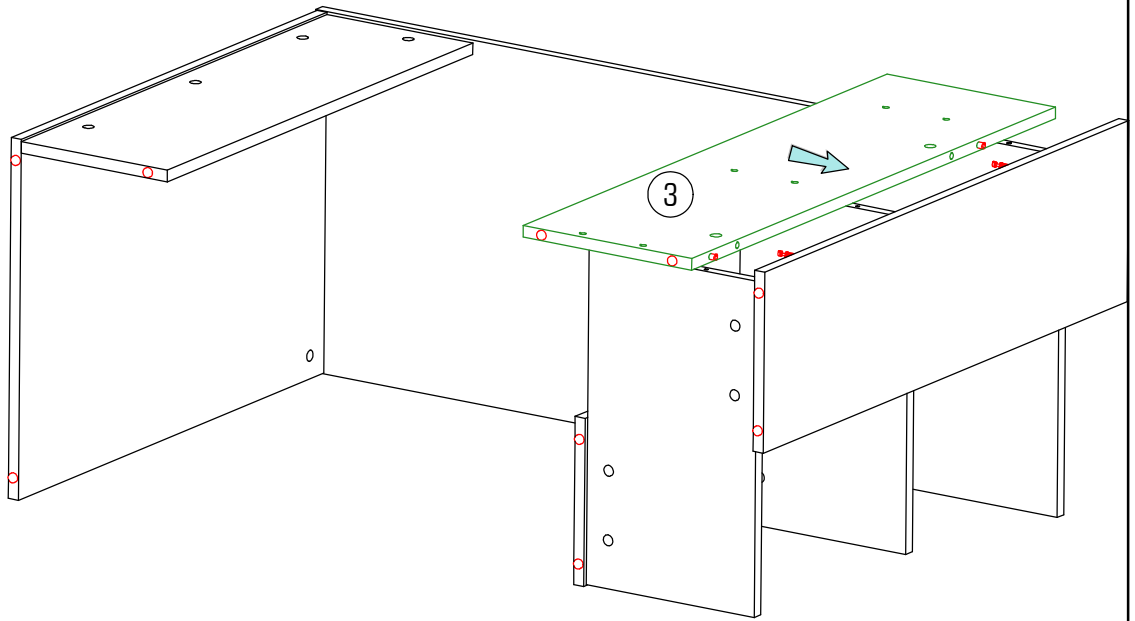
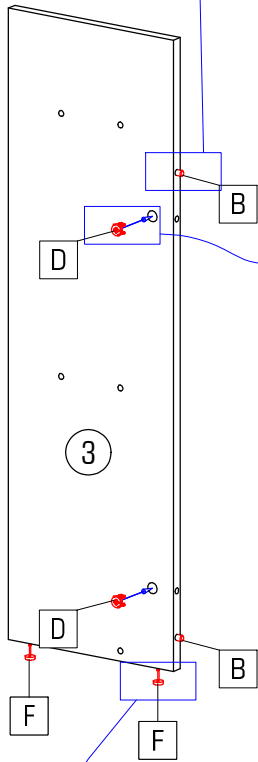
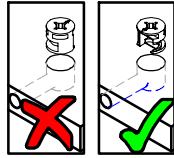
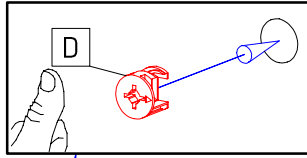
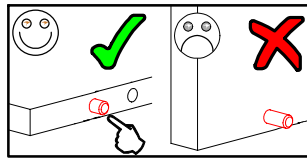
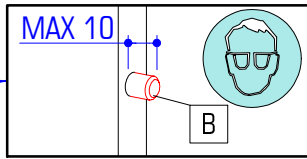
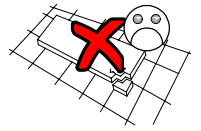
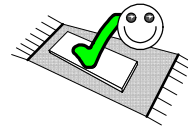

			
Ø8x30	Ø7x50	Ø15x13	
B 2x	C 6x	D 2x	F 2x



6/6 ANDREO NEW

	$\varnothing 20$		
G	8x	H	6x

